



A coleção Charm se destaca pelo requinte dos acabamentos manuais da marcenaria fina. As mesas são construídas com tampo de 30mm de espessura e pés torneados em madeira maciça.

The Charm collection is noted for its exclusive hand-made woodwork finish. The tops of the tables are made with 28mm thick and the legs are made with turned solid wood.

La colección Charm se destaca por el refinamiento de los acabamientos manuales de la ebanistería fina. Las mesas son construídas con una tapa de 28mm de espesor y patas torneadas de madera maciza.

CHARM
Studio Florense

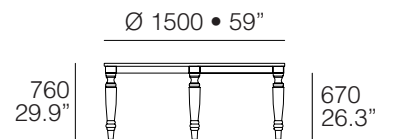
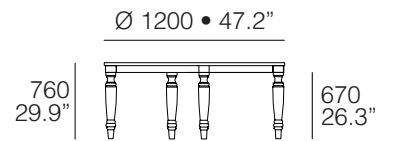
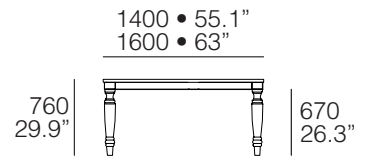
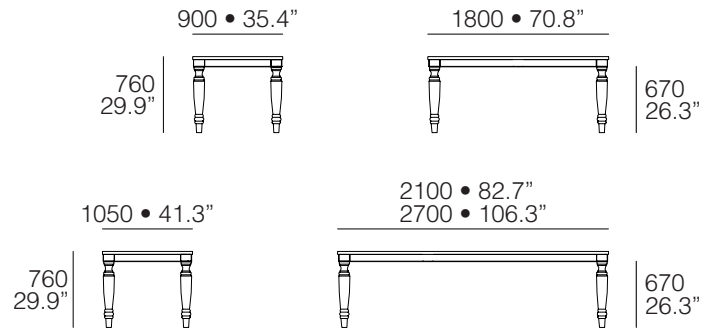

Acabamentos / Finishes / Acabados

Perolizado / Pearlescent / Nacarado

Perolizado High Gloss / High Gloss Pearlescent / Nacarado High Gloss



Microtextura / Microtexture / Microtextura

Microtextura High Gloss / High Gloss Microtexture / Microtextura High Gloss



Microtextura / Microtexture / Microtextura

Microtextura High Gloss / High Gloss Microtexture / Microtextura High Gloss

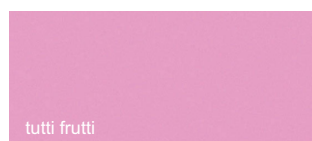
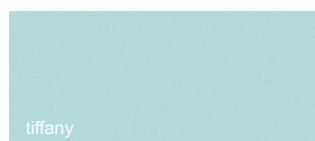
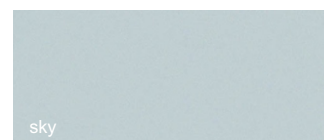
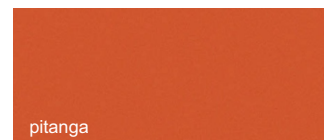
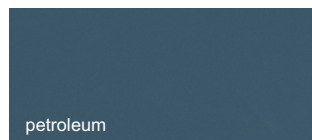
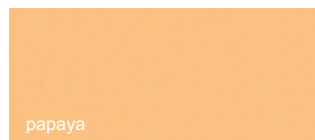
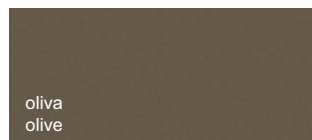
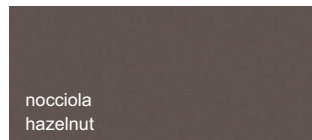
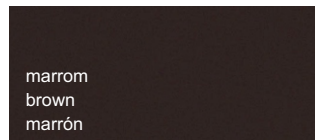
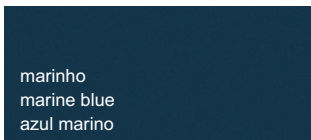
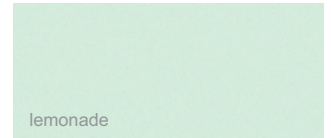
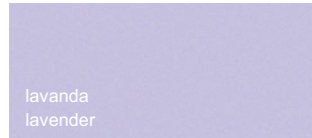
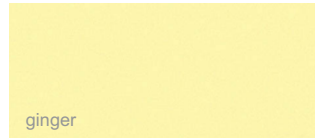

Anticato / Anticato / Anticato

